



2015 PRODUCT

CATALOG





All of **ATI's** products are manufactured in the **USA** at our facilities in southeastern Wisconsin.

Our vertically integrated manufacturing plants include a Molding Department equipped with Electric Servo Driven Plastic Mold Injection Presses with automated robotics, and a CNC Machining Department equipped with state of the art fully automated precision CNCs. Once our components are produced they are assembled and packaged in our assembly department. They are then shipped direct from the factory floor to customers throughout the world. Our company doesn't stop at manufacturing. ATI also bolsters its own Engineering and Product Design Team. Everything from Customer Service, to Tooling Maintenance, to Product Photography is performed under one roof. Trust ATI for all of your Gunstock and Firearm Accessory needs.



ATI HQ | Cedarburg, WI

ADVANCED DESIGN



SUPERIOR BUILD



UNPARALLELED PRODUCT



NEVER COMPROMISE 

ATIGunstocks.com



Product Spotlight

Introducing the **TactLite Adjustable Stock** - The industry's lightest adjustable stock, weighing in at just **5.85 Ounces**. The TactLite Stock Eliminates Snag Points and Provides a Secure Fit to the Buffer Tube Eliminating any Play between the Stock and the Buffer Tube with ATI's **TracLock System**

Color Key

- Black
- Flat Dark Earth
- Destroyer Gray
- Woodland Brown

ATI Catalog Index

- Taurus Scorpion **X2** Grips 4
- NEW** TactLite Stock 6
- AR-15 Components 8
 - TactLite Stock
 - Scorpion **X2** Grips
 - Forends
- Rifle Components 16
 - AK-47, Mossberg, Remington, Ruger 10/22, Ruger Mini 14 & THIRTY, Vepr, Saiga, SKS
- Shotgun Components 18
 - Baikal 133 / 135, CZ 712 / 720, Hatsan Escort, Mossberg 12 GA & 20 GA, Remington 870 12 & 20 GA, Saiga, Stoeger, Winchester SXP / 1200 & 1300
- Ruger AR-22 Stock Package 20
- CZ 512 Stock Package..... 22
- Raven Components 24
 - Benelli M4, Benelli Supernova, Mossberg 930, Remington 1100 / 11-87
- Halo Add-a-Shell Systems 26
 - Mossberg 500 / 590, Remington 870
- Hunting Rifle Stocks 28
 - Mosin Nagant, Enfield, Mauser, SKS
- Akita Components 30
 - CZ 712 / 720, Hatsan Escort, Mossberg 500 / 590, Remington 870 12 & 20 GA, Winchester SXP / 1200 & 1300
- Additional Stocks..... 34
- Rifle Accessories 35
- Shotgun Accessories..... 39

NEVER COMPROMISE

ATIgunstocks.com



SCORPION X2 GRIPS

Scorpion Grip Patent # 8,561,338 B2
Patent Pending Pistol Grip

1911 Inspired Rear Tang Creates Consistent Hand Placement and Reduces Muzzle Lift

Engineered Fit to the Shooter's Hand to Provide Outstanding Balance

Scorpion Recoil Grip Reduces Recoil & Muzzle Lift

Finger Elevation Contour Leads Finger to Trigger

Sure Grip V2 Texture for an Extremely Secure Hold in Wet and Dry Conditions

Curved Base Secures Grip and Aids in the Reduction of Muzzle Lift

Forward Angle Straightens Wrist

- Not Affected by Chemicals or Extreme Temperatures
- Single screw for easy installation
- Made in the USA
- Limited Lifetime Warranty

TAURUS® 38. SPL. ATI vs. OEM

Visual Comparison shows minimal additional length so not to hinder concealment while making it possible to get all three fingers onto the grip.



TAURUS® SMALL FRAME GRIP

- Fits Taurus®:** A.4.10.1005
- Model 85
 - Model 856
 - Model 605
 - Model 650
 - Model 850
 - Model 905
 - Model 94
 - Model 941
- NEW 2015**



- Does Not Fit Taurus®:**
- Poly Frames & Model 85 View

TAURUS® LARGE FRAME GRIP

- Fits Taurus®:** A.4.10.1015
- Model 17 Tracker 17
 - Model 992 Tracker 22
 - Model 627 Tracker 357
 - Model 45-410 The Judge



- Does Not Fit Taurus®:**
- Poly Frames & Public Defender Models

SCORPION X2 GRIPS

TAURUS GRIPS



Large Frame Grip



NEW 2015

Small Frame Grip

TactLite Stock **NEW 2015**

Patent Pending TactLite Stock

Introducing the **TactLite Adjustable Stock**

The industry's lightest adjustable stock, weighing in at just **5.85 Ounces**.

The TactLite Stock Eliminates Snag Points and Provides a Secure Fit to the Buffer Tube Eliminating any play between the Stock and the Buffer Tube with ATI's **TracLock System**

Cheekrest Options



Scorpion Recoil Pad Upgrade



* X2 Razorback Recoil Pad Optional

Dual Sided QD Mount

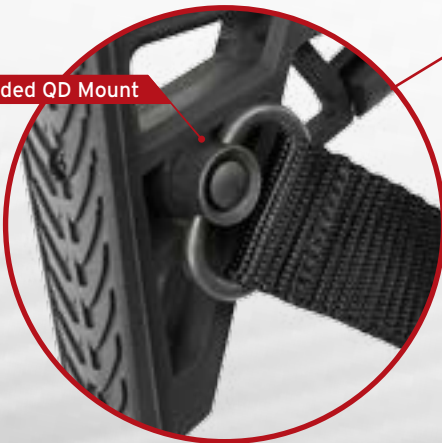

The Industries

Lightest Adjustable Stock

5.85 oz.

TracLOCK System



- Eliminates Horizontal & Vertical Movement
- Smooth & Quiet LOP

NEW 2015

TactLite Stock

Cross Platform Fit



MADE IN U.S.A.



TactLite Stock

AR-15 COMPONENTS

Scorpion Grip Patent # 8,561,338 B2
Forend Patent # 8,215,046 B2
Patent Pending Pistol Grip
Patent Pending TactLite Stock

Personalize your AR-15 with a wide variety of accessories from ATI. The must haves for your AR-15 are available at ATI. Start accessorizing and add form and function to your rifle today!

TactLite STOCK



NEW 2015

- Lightest Stock in the Industry
- 5.85 Ounces
- Provides one of the most secure fits to the buffer tube in the industry utilizing ATI's TracLock Mounting System
- Eliminates Snag Points
- Dual Sided QD Attachment Point
- No Interference with the Charging Handle

X2 GRIP



- Rear Tang for Repeatable hand placement
- Vertical Grip Angle
- Specific Geometry places the hand in the proper location and the index finger at the precise vertical and horizontal position for optimal placement on the trigger

TACTICAL FORENDS

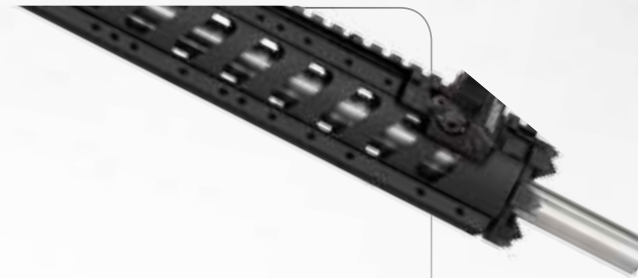

- Comfortable Outside Diameter for any Hand Size
- Modular Mounting System Allows for Exponential Accessory Configurations on the Forend
- Lightweight Durable Construction
- 6 & 8 Sided Configurations
- Free Float and 2 Piece

AR-15 COMPONENTS

AR-15 RIFLE



TactLite STOCK NEW 2015

Patent Pending TactLite Stock

The TactLite Stock is designed specifically for the M4 Platform with versions built to both Military and Commercial Specifications.

The New TactLite stock provides all of the benefits of other aftermarket stocks without the weight. Lighten your load with the lightest aftermarket AR-15 stock available today.

B.2.10.2211 | Commercial
B.2.10.2212 | Mil-Spec

No Interference with Charging Handle

Dual Sided QD Mount

Eliminates Snag Points

TracLOCK System

- Eliminates Horizontal & Vertical Movement
- Smooth & Quiet LOP

The Industries

Lightest Adjustable Stock

5.85 oz.

NEW 2015

TactLite STOCK

AR-15 RIFLE



MADE IN U.S.A.



AR-15 TactLite STOCK

SCORPION X2 GRIP

Scorpion Grip Patent # 8,561,338 B2

The Scorpion X2 Grip guides you to a repeatable engaged hand placement on your AR-15 every time you grasp the grip, saving you priceless seconds when they count the most.

Specifically Engineered Grip Dimensions Create the Optimal Distance from the Grip to the Trigger to Fit Most Hands

- Not Affected by Chemicals or Extreme Temperatures
- Single screw for easy installation
- Made in the USA
- Limited Lifetime Warranty

1911 Inspired Rear Tang Creates Consistent Hand Placement and Reduces Muzzle Lift

Finger Elevation Contour Leads Finger to Trigger

Engineered Fit to the Shooter's Hand to Provide Outstanding Balance

Sure Grip V2 Texture for an Extremely Secure Hold in Wet and Dry Conditions

Scorpion Recoil Grip Reduces Recoil & Muzzle Lift

Curved Base Secures Grip and Aids in the Reduction of Muzzle Lift

VERTICAL GRIP ANGLE

More Vertical Angle for Improved Grip & Ergonomics

Sure Grip V2 Texture Close-up



Black
A.5.10.2342



Flat Dark Earth
A.5.20.2343



Destroyer Gray
A.5.40.2343



SCORPION X2 GRIPS

AR-15 RIFLES



MADE IN U.S.A.



AR-15 X2 GRIP

AR-15 FORENDS

Forend Patent# 8,215,046 B2

The possibilities are endless with ATI's **6 and 8-Sided Aluminum Forends**

What makes these forends revolutionary is the ability to **position rails at 45° increments** around the circumference of the forend to the exact position desired along the length of the forend. Install any accessory in any position that is most comfortable for you; your options to customize and add accessories are virtually infinite!

- Constructed of **Military Type III Anodized, 6061 T6 Aluminum**.
- Mounting long distance optics on the top rail location and a short distance sight onto the 45° rail location **makes switching between long range and short range targeting as quick as a twist of the wrist**.
- **Install accessories to the exact position of comfort**, no longer limited to rails at 90°.
- **Available in Carbine, Mid-Length Rifle Length or 15" Lengths**
- Compatible with ATI's **Aluminum Picatinny Rails Available in 2", 3", 4", 6", 9", 12" and 15", Both in Standard Military and Low Profile Heights**.

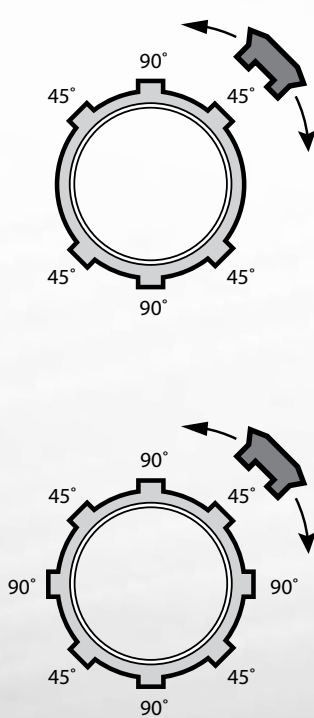

6-Sided Aluminum Forend Weights

Product	Weight
6-Sided Carbine Length Free-Float Forend A.5.10.1170	5.1 oz. 145 g.
6-Sided Mid-Length Free-Float Forend A.5.10.2537	7.1 oz. 201 g.
6-Sided Rifle Length Free-Float Forend A.5.10.1174	9.1 oz. 258 g.
6-Sided 15" Free-Float Forend A.5.10.1422	11.9 oz. 337 g.

* Forend weights do not include the weight of picatinny rails or accessories.

** Forend packages available with and without picatinny rails and assembly hardware.

8-Sided Aluminum Forend Weights

Product	Weight
8-Sided Carbine Length Free-Float Forend A.5.10.1140	5.2 oz. 147 g.
8-Sided Mid-Length Free-Float Forend A.5.10.2535	7.2 oz. 204 g.
8-Sided Rifle Length Free-Float Forend A.5.10.1150	9.3 oz. 263 g.
8-Sided 15" Free-Float Forend A.5.10.1420	12 oz. 340 g.

* Forend weights do not include the weight of picatinny rails or accessories.

** Forend packages available with and without picatinny rails and assembly hardware.

FORENDS

AR-15 RIFLE



15"



Carbine Length - 6"

Mid-Length - 9"

Rifle Length - 12"

NEW 2015

Rifle COMPONENTS

ATI's TactLite, Strikeforce and Talon T2 Stocks will transform your rifle into a more functional weapon with an aesthetic appeal that is unsurpassed. Upgrade your rifle today!

NEW 2015

Black ■

Flat Dark Earth ■

Destroyer Gray ■

Additional product information available on pages 35-38



• **AK-47**

Stock | B.2.10.1092 | ■ ■ ■



• **Ruger Mini 14 / Mini THIRTY**

Stock System | B.2.10.1210 | ■ ■ ■



• **Ruger 10/22**

Stock System | B.2.10.1216 | ■ ■ ■



• **Ruger 10/22 - AR-22**

Stock System | B.2.10.2210 | ■



• **Remington 7600**

Stock | Grip | B.2.10.2210 | ■



• **Saiga**

Stock | B.2.10.1272 | ■ ■ ■



• **SKS**

Stock System | B.2.10.1232 | ■ ■ ■



• **VEPR**

Stock | B.2.10.1300 | ■

NEW 2015

TactLite ON RIFLE

MINI 14 / MINI THIRTY



Cheekrest options

- Both options included with TactLite Stock
- DuPont® Extreme Temperature Glass Reinforced Polymer
- Easy Adjustability



1/2" Rise



1 1/4" Rise

SHOTGUN COMPONENTS

Take your Pump Action Shotgun to the next level with ATI's TactLite T2 Stock. ATI's TactLite T2 Shotgun Line featuring the TactLite stock provides you with maximum comfort and adjustability for any situation.

NEW 2015 Black ■ Flat Dark Earth ■ Destroyer Gray ■

Additional product information available on pages 39-42



• **CZ 712 / 720**

Stock | Grip | B.1.10.1452 | ■
*Forend only for 720 Model



• **Baikal 133 / 153**

Stock | Grip | B.1.10.1051 | ■



• **Hatsan Escort**

Stock | Grip | B.1.10.1440 | ■ ■ ■



• **Mossberg 500/590**

Stock | Grip | B.1.10.1140 | ■ ■ ■



• **Remington 870 12 & 20 GA**

Stock | Grip | B.1.10.1141 | ■ ■ ■



• **Saiga 12 GA**

Stock | Grip | B.1.10.1146 | ■ ■ ■



• **Stoeger P350 12 GA**

Stock | Grip | B.1.10.1421 | ■ ■ ■



• **Winchester SXP 12 GA**

Stock | Grip | B.1.20.1005 | ■ ■ ■



• **Winchester 1200/1300 12 GA**

Stock | Grip | B.1.20.1142 | ■ ■ ■

NEW 2015

TactLite ON SHOTGUN

MOSSBERG 590



Cheekrest options

- Both options included with most TactLite Stocks
- DuPont® Extreme Temperature Glass Reinforced Polymer
- Easy Adjustability



1/2" Rise



1 1/4" Rise



RUGER AR-22 STOCK SYSTEM **NEW 2015**

Scorpion Grip Patent # 8,561,338 B2
Forend Patent# 8,215,046 B2
Patent Pending Stock System

ATI's AR-22 Conversion Kit provides the ultimate make over for your Ruger 10/22. The AR-22 kit converts your Ruger 10/22 into an almost indistinguishable AR-15 Look-a-Like.



Receiver Mount

The Receiver Mount is the Key Support Point for the AR-22, which is enforced with the Aluminum Top Rail Spanning the Length of the Receiver Chassie and Aluminum Forend.



System Components

Six Sided Stock System | B.2.10.2210

Eight Sided Stock System | B.2.10.2200

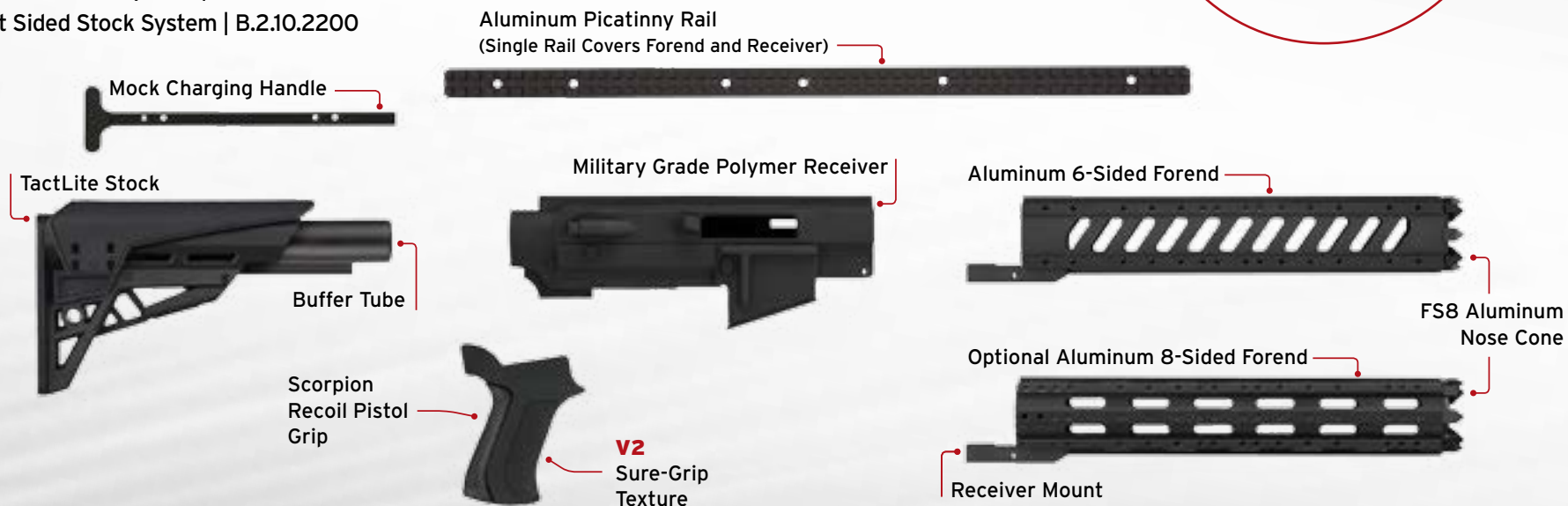

NEW 2015

AR-22 STOCK SYSTEM



RUGER 10/22

CZ 512 STOCK SYSTEM NEW 2015

Scorpion Grip Patent # 8,561,338 B2
Forend Patent# 8,215,046 B2
Patent Pending Stock System

The CZ512 Conversion Kit transforms the CZ 512 into what may possibly be the coolest rimfire rifle on the market today with an adjustable six position stock and AR-15 style Free-Float Forend.



Barrel Block Mount

With the Conversion to an Aluminum Forend which is Mounted to the Barrel, we have Provided an Aluminum Barrel Block. The Block Stabilizes the Forend and Barrel for Optimal Accuracy.



System Components

Six Sided Stock System | B.2.10.2217



NEW 2015

CZ 512 STOCK SYSTEM

RIMFIRE RIFLE



RAVEN COMPONENTS

Scorpion Grip Patent # 8,561,338 B2
 Patent Pending Stock
 Patent Pending Magazine Tube Tri-Rail
 Patent Pending Cheekrest
 Patent Pending Heatshield

Available for:



• Benelli® M4

Stock Package | A.1.10.1430 | ■

M4 Components

Stock



Heatshield



Forend



Magazine Tube



Mag Follower



Mag Tube Shroud



• Benelli® Supernova

Stock | Grip | A.1.10.1435 | ■

Adjustable Cheekrest

Adjusts in .01" Increments to Provide the Perfect Height for any User

Maintains same Cheekrest height of OEM Stock in the fully Collapsed Position

3/4"

Ergonomic Rear Dial for quick and easy Cheekrest Adjustments

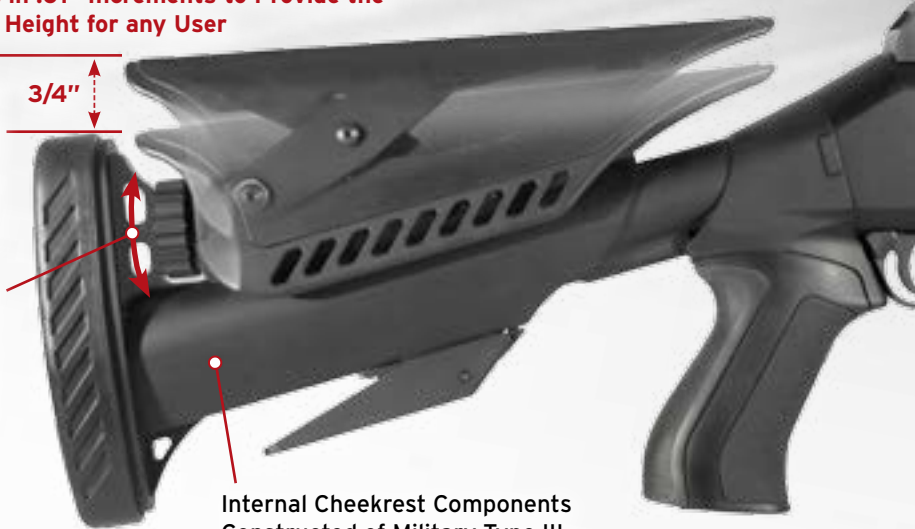

Internal Cheekrest Components Constructed of Military Type III Anodized, 6061 T6 Aluminum



• Mossberg 930

Stock | Grip | A.1.10.1433 | ■



• Remington 1100 / 11-87

Stock | Grip | A.1.10.1438 | ■

RAVEN STOCKS

BENELLI® SUPERNOVA



MADE IN U.S.A.



RAVEN STOCKS

HALO ADD-A-SHELL SYSTEMS

Side Saddle Patent US 8,316,569 B1
Add-a-Shells Patent US 8,528,245 B2

A.5.10.1002



Mossberg 500/590

9 Shell Customizable Add-A-Shell Configurations

- CNC Machined from 6061 T6 Aluminum & Military Type III Hardcoat Anodized
- Add-A-Shells Mount in any Location on the Side Saddle
- Mount as many or as few Add-A-Shells as desired
- Customize your Shell Configuration for any Task at Hand



6 Shell Configuration | A.5.10.1001

A.5.10.1006



Remington 870

7 Shell Customizable Add-A-Shell Configurations

- CNC Machined from 6061 T6 Aluminum & Military Type III Hardcoat Anodized
- Add-A-Shells Mount in any Location on the Side Saddle
- Mount as many or as few Add-A-Shells as desired
- Customize your Shell Configuration for any Task at Hand



5 Shell Configuration | A.5.10.1005

Mossberg 500/590 | 9 Shell



Remington 870 500/590 | 7 Shell



ADD-A-SHELL SYSTEMS

REMINGTON 870
MOSSBERG 500/590



MADE IN U.S.A.



HALO ADD-A-SHELL

HUNTING RIFLE STOCKS

Renovate a classic with ATI's Aftermarket Military Surplus stocks. In a matter of minutes you can breathe new life into your Mosin, Enfield, Mauser and SKS Rifles by installing an ATI Monte Carlo Stock.

• Mosin Nagant

Stock System | A.2.30.1300 ■
MOIO300 ■

Fits:

Most 91/30 Rifles & M-38,
M-44 Carbines

Most Mosin Nagant Variants
7.62x54R



Scorpion
Recoil Pad



Optional Scope Mount
A.5.10.2281

Optional Bolt Handle
MOIO700

• Enfield

Stock System | A.2.30.1296 ■
A.2.30.1297 ■
ENFO013 ■
ENFO041 ■

Fits:

ENFO013: Most 303 No. 1 Mk 3 &
.308 No. 1

ENFO041: Most Mk 3 303 and
.308 No. 4, Mk 1, Mk 2, Mk 5



Optional Scope Mount
ENFO113 ENFO141

• Mauser

Stock System | A.2.30.1310 ■
MSS1500 ■

Fits:

Fits Standard Bent Bolt, Large-Ring, German K-98s, Czech VZ-24, Yugo 48/48a, Turkish 1903/1937/1938/1946 7mm or 8mm Caliber. Will not fit large-ring Swedish M38/96 6.5x55 or small-ring Mausers. Must convert straight bolt or "wide arc" bolt Mausers to bent bolt with our Bolt Handle (#MBH1800) to use a standard scope.



Scorpion
Recoil Pad



Built-In Scope Mount

Optional Bolt Handle
MBH1800

• SKS

Stock System | A.2.30.1305 ■
SKS0300 ■

Fits:

All SKS Rifles



Scorpion
Recoil Pad

RIFLE STOCKS



MOSIN NAGANT

AKITA COMPONENTS

CZ USA • HATSAN ESCORT • MAVERICK
MOSSBERG • REMINGTON • WINCHESTER

Akita Patent # D639,891S
Mount Patent # 6,374,528 B1

The PERFECT FIT

People come in all shapes and sizes, ranging from tall to short and everything in between, so why shouldn't your stock as well? No longer do you have to shoot a gun that doesn't fit you.

Shoot one that does! ATI's Akita Adjustable Stock has one of the longest AND the shortest lengths of pull in the industry! Perfect for every shooter, as the length of pull can be easily adjusted from 12 3/8" to 14 3/8". Now the stock that fits you while wearing a T-shirt in the summer heat can be easily adjusted to fit you while wearing a winter coat when the leaves turn brown.

- One Push of the Quick Release Button will Adjust the Length of Pull
- Adjustable Cheekrest for Added Comfort (1/2")
- Adjustable 4 Position Stock
- Adjustable Length of Pull - 12 3/8" to 14 3/8"
- Available in Black, Woodland Brown and Flat Dark Earth

*Fits CZ 712 (12 GA) and 720 (20 GA)
Hatsan Escort 12 GA Pump Action Models
Mossberg 500*/535/590/835 12 GA and 20 GA Models
Remington 870 12 GA and 20 GA Models
Winchester 1200/1300 and SXP 12 GA Models
Maverick 88*

*Forends on the Maverick 88 and newer model Mossberg 500A, B & C cannot be replaced because action bars are attached to forend.

One Push of the Quick Release Button will Adjust the Length of Pull

12³/₈" to 14³/₈"
Adjustable Length of Pull

Quick Release Button

The biggest complaint is that we hide the button too well.

Sure to be the perfect fit
for every sportsman...
of all ages and sizes!



HUNTING STOCKS

WINCHESTER SXP



AKITA COMPONENTS

Custom fit your ATI Akita Stock to your specific firearm, whether it is a CZ 712 Semi-Auto, a Remington 870 or a Winchester 1200/1300.

**The 12 GA Maverick 88 and Mossberg 500/535/590/835 Akita Stocks fit directly onto the receiver and do not require an Akita Aluminum Mount.*

Black ■ Flat Dark Earth ■ Woodland Brown ■

Additional product information available on pages 39-42



• CZ 712 Semi-Auto 12 GA

Stock | A.1.10.1178 | ■



• CZ 720 Semi-Auto 20 GA

Stock | A.1.10.1453 | ■



• Hatsan Escort 12 GA

Stock | A.1.30.1023 | ■ ■ ■



• Mossberg 500/590

Stock | A.1.30.1286 | ■ ■ ■



• Remington 870 12 GA / 20 GA

Stock | A.1.30.1336 | ■ ■ ■



• Winchester 1200/1300 12 GA

Stock | A.1.10.1386 | ■ ■ ■



• Winchester SXP 12 GA

Stock | A.1.30.1176 | ■ ■ ■

AKITA COMPONENTS

CZ 720 & HATSAN ESCORT



ADDITIONAL STOCKS

ATI's TactLite, Fiberforce and Top Folder Stocks will Transform your rifle into a more functional weapon with an aesthetic appeal that is unsurpassed. Upgrade your rifle today!

Black ■ Flat Dark Earth ■ Destroyer Gray ■



• **Saiga Fiberforce**

Stock | Grip | A.2.10.1276 | ■ ■ ■



• **AK-47 Fiberforce**

Stock | Grip | Forend | MAK0100 | ■ ■ ■



• **SKS Fiberforce**

Stock System | SKS3000 | ■ ■ ■



• **Top Folder**

Stock | Grip | TFS0600 | ■ ■ ■



• **Ruger 10/22 Fiberforce**

Stock System | RUG3000 | ■ ■ ■



• **Marlin Fiberforce**

Stock System | MAR3000 | ■ ■ ■

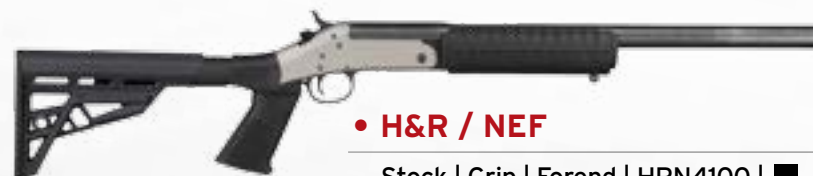

• **H&R / NEF**

Stock | Grip | Forend | HRN4100 | ■

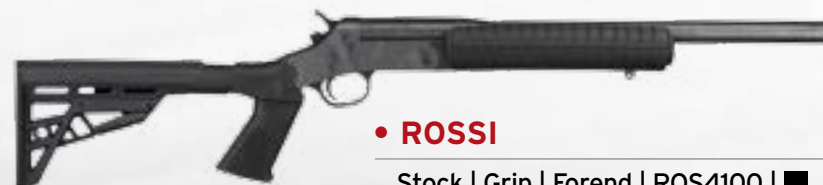

• **ROSSI**

Stock | Grip | Forend | ROS4100 | ■

RIFLE ACCESSORIES



- TactLite Stock** A.2.10.2211, A.2.10.2212
- Lightest Aftermarket Stock - 5.85 Oz
 - No Snag Points
 - Optional Adjustable Cheekrest(s) (1 1/4")
 - TracLOCK System
 - Provides a Tight Fit to the Buffer
 - Eliminates Horizontal and Vertical Movement
 - Provides Smooth and Quiet LOP Adjustment



- AR-15 Scorpion Pistol Grip** A.5.10.2342, A.5.20.2343 & A.5.40.2343
- NEW V2 Sure-Grip Texture
 - Absorbs Energy, Doesn't Transfer Energy to Shooter
 - Not Affected by Chemicals or Extreme Temperatures
- Scorpion Grip Patent # 8,561,338 B2*



- Scorpion Razorback Recoil Pad** A.5.10.2301
- Absorbs Energy, Doesn't Transfer Energy to Shooter
 - Not Affected by Chemicals or Extreme Temperatures



- Forend Pistol Grip** FPG0100, A.5.20.2495 & A.5.40.2495
- Five Position
 - DuPont® Extreme Temperature Glass Reinforced Polymer



- AR-15 Mag Covers - Black** AR15223
- Protect Your Mags from Dust and Humidity
 - Flexible Rubber
 - 4 Per Pack



- AR-15 Mag Covers - Clear** A.5.10.2340
- Protect Your Mags from Dust and Humidity
 - Flexible Rubber
 - 4 Per Pack



- AR-15 Forend Swivel Stud Kit** A.5.10.2390
- Easy Installation



- FS8 Nose Cone** A.5.10.2360
- Military Type III Anodized, 6061 T6 Aluminum
 - Anchors into Multiple Surfaces for Increased Stability & Accuracy



- AR-15 Commercial Buffer Tube Assembly** A.5.10.1050
- Military Type III Anodized, 6061 T6 Aluminum
 - Spring Steel Buffer Spring, Castle Nut, and Locking Ring



- AR-15 Military Spec. Buffer Tube Assembly** A.5.10.2240
- Military Type III Anodized, 6061 T6 Aluminum
 - Spring Steel Buffer Spring, Castle Nut, and Locking Ring



- AR-15 Forend Sling Swivel Kit** A.5.10.2385
- Laser Etched Sling Swivel
 - Easy Installation



- ATI Sling Swivel** A.5.10.2506
- Easy Installation
 - High Quality E-Coated Steel
 - Accepts up to 1 1/4" Wide Slings
 - Virtually Indestructible

RIFLE ACCESSORIES

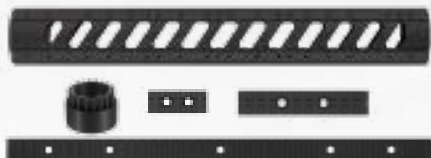

**AR-15 Aluminum 6-Sided
15" Free-Float Forend with Utility
Rail Package & Slotted Barrel Nut**
A.5.10.1177

- Military Type III Anodized, 6061 T6 Aluminum
- Includes Slotted Barrel Nut
- Utility Rail Package
 - One 15" Low Profile Picatinny Rail
 - One 4" Picatinny Rail
 - One 2" Picatinny Rail

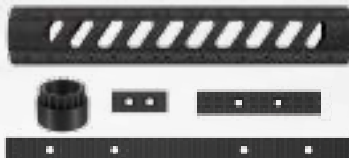

**AR-15 Aluminum 6-Sided
Rifle Length Free-Float Forend
with Utility Rail Package &
Slotted Barrel Nut** A.5.10.1175

- Military Type III Anodized, 6061 T6 Aluminum
- Includes Slotted Barrel Nut
- Utility Rail Package
 - One 12" Low Profile Picatinny Rail
 - One 4" Picatinny Rail
 - One 2" Picatinny Rail



**AR-15 Aluminum 6-Sided
Mid-Length Free-Float Forend
with Utility Rail Package & Slotted
Barrel Nut** A.5.10.2538

- Military Type III Anodized, 6061 T6 Aluminum Includes Slotted Barrel Nut
- Utility Rail Package
 - One 9" Low Profile Picatinny Rail
 - One 4" Picatinny Rail
 - One 2" Picatinny Rail



**AR-15 Aluminum 6-Sided
Carbine Length Free-Float Forend
with Utility Rail Package & Slotted
Barrel Nut** A.5.10.1171

- Military Type III Anodized, 6061 T6 Aluminum
- Includes Slotted Barrel Nut
- Utility Rail Package
 - One 6" Low Profile Picatinny Rail
 - One 4" Picatinny Rail
 - One 2" Picatinny Rail



**AR-15 Aluminum 8-Sided
15" Free-Float Forend with Utility
Rail Package & Slotted Barrel Nut**
A.5.10.1145

- Military Type III Anodized, 6061 T6 Aluminum
- Includes Slotted Barrel Nut
- Utility Rail Package
 - One 15" Low Profile Picatinny Rail
 - One 4" Picatinny Rail
 - One 2" Picatinny Rail



**AR-15 Aluminum 8-Sided
Rifle Length Free-Float Forend with
Utility Rail Package & Slotted Barrel
Nut** A.5.10.1143

- Military Type III Anodized, 6061 T6 Aluminum
- Includes Slotted Barrel Nut
- Utility Rail Package
 - One 12" Low Profile Picatinny Rail
 - One 4" Picatinny Rail
 - One 2" Picatinny Rail

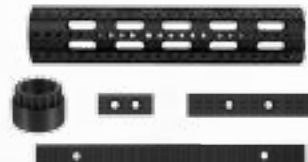

**AR-15 Aluminum 8-Sided
Mid-Length Free-Float Forend with
Utility Rail Package & Slotted Barrel
Nut** A.5.10.2536

- Military Type III Anodized, 6061 T6 Aluminum
- Includes Slotted Barrel Nut
- Utility Rail Package
 - One 9" Low Profile Picatinny Rail
 - One 4" Picatinny Rail
 - One 2" Picatinny Rail

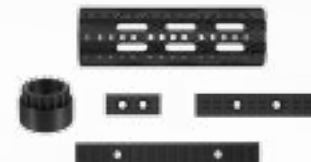

**AR-15 Aluminum 8-Sided
Carbine Length Free-Float Forend
with Utility Rail Package & Slotted
Barrel Nut** A.5.10.1144

- Military Type III Anodized, 6061 T6 Aluminum
- Includes Slotted Barrel Nut
- Utility Rail Package
 - One 6" Low Profile Picatinny Rail
 - One 4" Picatinny Rail
 - One 2" Picatinny Rail

RIFLE ACCESSORIES



6" Ruger® Mini-14® Mini-Thirty® Aluminum Bottom Picatinny Rail A.5.10.2040

- Military Type III Anodized, 6061 T6 Aluminum



7" Ruger® Mini-14® Mini-Thirty® Aluminum Top Picatinny Rail A.5.10.2050

- Military Type III Anodized, 6061 T6 Aluminum



15", 12" & 6" Aluminum Low Profile Free-Float Picatinny Rails

- Allows for the Continuation of the AR-15 Upper Receiver Rail Along The Length of the Rifle
- Can be Installed Flush to the AR-15 Upper Receiver Rail
- Military Type III Anodized, 6061 T6 Aluminum



2", 3", 4", 6" & 12" Aluminum Picatinny Rails

- Military Type III Anodized, 6061 T6 Aluminum
- Position Rails at 45° Increments Around the Circumference of the Forend



Ruger® 10/22® Aluminum Rail Package A.5.10.1070

- Military Type III Anodized, 6061 T6 Aluminum
- One 4" Picatinny Rail
- Two 2" Picatinny Rails



Ruger® Mini-14® Mini-Thirty® Aluminum Picatinny Rail Package A.5.10.1080

- Military Type III Anodized, 6061 T6 Aluminum
- One 7" Top Picatinny Rail
- One 6" Bottom Picatinny Rail
- One 2" Picatinny Rail with Swivel
- Two 2" Picatinny Rails

Also available as individual components

Product #	Length	Height	Weight
A.5.10.1365	15"	.3"	2.48 oz.
A.5.10.1361	12"	.3"	1.87 oz.
A.5.10.2540	9"	.3"	1.48 oz.
A.5.10.1351	6"	.3"	1.09 oz.

Product #	Length	Height	Weight
A.5.10.1320	2"	.4"	0.576 oz.
A.5.10.1330	3"	.4"	0.672 oz.
A.5.10.1340	4"	.4"	0.992 oz.
A.5.10.1350	6"	.4"	1.568 oz.
A.5.10.2539	9"	.4"	2.080 oz.
A.5.10.1360	12"	.4"	2.592 oz.

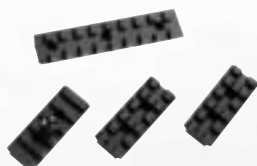

AK-47 Aluminum Rail Package A.5.10.1090

- Military Type III Anodized, 6061 T6 Aluminum
- One 4" Picatinny Rail
- One 2" Picatinny Rail with Swivel
- Two 2" Picatinny Rails

Also available as individual components.



4" Aluminum Picatinny Rail A.5.10.2030

- Military Type III Anodized, 6061 T6 Aluminum

Fits ATI's SKS Strikeforce Stocks



2" Aluminum Picatinny Rail A.5.10.2060

- Military Type III Anodized, 6061 T6 Aluminum

Fits ATI's SKS Strikeforce Stocks



2" Aluminum Picatinny Rail With Swivel Stud A.5.10.2000

- Military Type III Anodized, 6061 T6 Aluminum
- One Swivel Stud

RIFLE ACCESSORIES



Single Point Sling A.5.10.1008

- 1" Black Nylon Sling
- High Strength Bungee Cord
- Cushioned Non-Slip Shoulder Pad with ATI Logo
- Attaches with Nylon-Wrapped Industrial Carabiner



ATI Nylon Sling A.5.10.2260

- Attaches to any Swivel Stud
- Black Nylon
- Laser Etched Sling Swivel
- Leather Embossed ATI Logo



AK Scorpion Pistol Grip A.5.10.2346, A.5.20.2346 & A.5.40.2346

- Absorbs Energy, Doesn't Transfer Energy to Shooter
- Not Affected by Chemicals or Extreme Temperatures

Scorpion Grip Patent # 8,561,338 B2



AK-47 Handguards

AKA3500, A.5.20.2436 & A.5.40.2436

- Ventilated Handguard
- One 4" & Three 2" Picatinny Rails
- Blank Inserts for When Rails are Not in Use



Fiberforce Recoil Pad SKS0550

- Not Affected by Chemicals or Extreme Temperatures
- Non-Slip Removable Rubber Recoil Pad
- Simply Slip-On
- Absorbs Recoil
- Adds 1" Length

Fits: ATI's Fiberforce Stocks for AK-47, Saiga, and SKS



AR-15 Civilian (Commercial) Buffer Tube A.5.10.1000

- Constructed of Military Type III Anodized, 6061 T6 Aluminum
- Commercial Diameter Tube for Maximum Fit into Commercial Buttstock



AR-15 Military Buffer Tube A.5.10.2250

- Constructed of Military Type III Anodized, 6061 T6 Aluminum
- Military Diameter Threads for Maximum Fit into AR-15 Receiver



Expandable Ammo Carrier SH06200

- Quick & easy access to extra 410/rifle rounds
- Holds 10 rounds
- DuPont® Extreme Temperature Glass Reinforced Polymer



Universal Featherweight Bipod BIP0300

- Can Swivel or Remain Fixed
- Easily Adjusted from 9" to 13"
- Weighs Only 6 oz.
- Extra Swivel Stud Included
- DuPont® Extreme Temperature Glass Reinforced Polymer



SKS Featherweight Non-Swivel Bipod BIP0700

- Mounts to Bayonet Lug. Push "Snap-N-Lock" Button to Fold Legs Forward, Rearward or Downward.
- Fixed Bipod
- Easily Adjusts from 9" to 13"
- Weighs Only 6 Oz.
- Non-Slip Rubber Feet



Pivot Housing Scorpion Retro Kit A.5.10.2425

- Side Folding Kit
- Allows the Addition of the Scorpion Recoil Pistol Grip to Previous Generations of ATI's Mini-14® Strikeforce Stock
- Absorbs Energy, Doesn't Transfer Energy to Shooter



Non-Side Folding Fixed Pivot Housing Scorpion Retro Kit A.5.10.2426

- Non-Side Folding Kit
- Allows the Addition of the Scorpion Recoil Pistol Grip to Previous Generations of ATI's Mini-14® Strikeforce Stock
- Absorbs Energy, Doesn't Transfer Energy to Shooter

SHOTGUN ACCESSORIES



- TactLite Stock** A.2.10.2211, A.2.10.2212
- Lightest Aftermarket Stock - 5.85 Oz
 - No Snag Points
 - Optional Adjustable Cheekrest(s) (1 1/4")
 - TracLOCK System
 - Provides a Tight Fit to the Buffer
 - Eliminates Horizontal and Vertical Movement
 - Provides Smooth and Quiet LOP Adjustment



- Talon T2 Shotgun Rear Pistol Grip**
A.5.10.1660, A.5.20.1660, A.5.40.1660
- Extended Scorpion Material to Reduce Recoil and Discomfort to the Shooter's Hand and Thumb
 - Sure-Grip Texture
 - Eliminates the Felt Punch of the Recoil
Scorpion Grip Patent # 8,561,338 B2



- Scorpion X2 Recoil Pad** A.5.10.1015
- Absorbs More Than Twice the Energy, Doesn't Transfer Energy to Shooter
 - Not Affected by Chemicals or Extreme Temperatures
 - Increased Thickness for Recoil Absorption of Heavy Loads



- Scorpion Razorback Recoil Pad**
A.5.10.2301
- Absorbs Energy, Doesn't Transfer Energy to Shooter
 - Not Affected by Chemicals or Extreme Temperatures



- Akita Forend**
12 GA: A.1.10.1172, A.1.20.1172, A.1.30.1172, A.1.40.1172
20 GA: A.5.10.1041, A.5.20.1041, A.5.30.1172, A.5.40.1041
- Sure-Grip Texture
 - DuPont® Extreme Temperature Glass Reinforced Polymer



- Tactical Shotgun Forend**
12 GA: TSG0300, A.1.20.1162, A.1.40.1162
20 GA: A.5.10.1037, A.5.20.1037, A.5.40.1037
- Two 2" Picatinny Rails
 - DuPont® Extreme Temperature Glass Reinforced Polymer



- Talon 5-Sided Aluminum Shotgun Forend**
12 GA: A.5.10.1160
20 GA: A.5.10.1161
- Military Type III Anodized, 6061 T6 Aluminum
Forend Patent# 8,215,046 B2



- Mag-Socket Wrench Set** A.5.10.2395
- Allows for Easy Disassembly and Installation of Forends
 - Constructed of Military Type III Anodized, 6061 T6 Aluminum



- 7 & 8 Shot Fluted Aluminum Mag Extension**
- Holds an Additional 2 & 3 - 2 3/4" Shotgun Shells
 - Constructed of Military Type III Anodized, 6061 T6 Aluminum
 - Choose between three caps

Cap	CZ USA		Hatsan Escort		Remington 870		Stoeger		Supernova		Winchester	
	7 Shot	8 Shot	7 Shot	8 Shot	7 Shot	8 Shot	7 Shot	8 Shot	7 Shot	8 Shot	7 Shot	8 Shot
Standard	A.5.10.1627	A.5.10.1629	A.5.10.1530	A.5.10.1540	A.5.10.1653	A.5.10.1655	A.5.10.1533	A.5.10.1543	A.5.10.2523	A.5.10.2526	A.5.10.1670	A.5.10.1672
Swivel Stud	A.5.10.1019	A.5.10.1013	A.5.10.1531	A.5.10.1541	A.5.10.1657	A.5.10.1658	A.5.10.1534	A.5.10.1544	A.5.10.2524	A.5.10.2527	A.5.10.1674	A.5.10.1675
Stand-Off	A.5.10.1628	A.5.10.1018	A.5.10.1532	A.5.10.1542	A.5.10.1654	A.5.10.1656	A.5.10.1535	A.5.10.1545	A.5.10.2525	A.5.10.2528	A.5.10.1671	A.5.10.1673

*CZ 10 Shot also available

SHOTGUN ACCESSORIES



Mossberg Halo Add-a-Shell

- A.5.10.1630
- Military Type III Anodized, 6061 T6 Aluminum
 - Mounts to Top of Receiver using Existing Screw Holes
 - Mounting Locations for Add-a-shells and Top Rail

*Fits Mossberg 500 & 590
Side Saddle Patent US 8,316,569 B1*



Remington Halo Add-a-Shell

- A.5.10.1665
- Military Type III Anodized, 6061 T6 Aluminum
 - Mounts to Top of Receiver using Existing Screw Holes
 - Mounting Locations for Add-a-shells and Top Rail

*See website for more details
Side Saddle Patent US 8,316,569*



Add-a-Shell

- A.5.10.0001, A.5.10.0003 & A.5.10.0005
- One, Three, or Five Packs
 - Military Type III Anodized, 6061 T6 Aluminum
 - Add as Many Shells as Desired in any Configuration

Add-A-Shell Patent US 8,528,245 B2



Halo Add-a-Shell 6" Top Rail

- A.5.10.1631
- Military Type III Anodized, 6061 T6 Aluminum
 - Mount Optics or Other Accessories Securely to the Top Rail



Aluminum Halo Ghost Ring Sights

- A.5.10.2505
- Military Type III Anodized, 6061 T6 Aluminum
 - CNC Machined
- Front & Rear Sights



Forend Pistol Grip

- FPG0100, A.5.20.2495 & A.5.40.2495
- Five Position
 - DuPont® Extreme Temperature Glass Reinforced Polymer



2" Aluminum Picatinny Rail

- A.5.10.2060
- Military Type III Anodized, 6061 T6 Aluminum
- Fits ATI's SKS Strikeforce Stocks*



Tactical Forend Aluminum Rail Package

- A.5.10.1060
- Military Type III Anodized, 6061 T6 Aluminum
 - One 2" Left Picatinny Rail
 - One 2" Right Picatinny Rail



Tactical Shotgun Thumb Adhesive Pad

- A.5.10.2380
- 3M Industrial Self-Adhesive Cheekrest Pad
 - Provides Extra Comfort When Shooting

Fits ATI's TSG0100 Tactical Shotgun Stock



Shotshell Holder

- SH00500
- Quick & Easy Access to Extra 12 GA Rounds
 - Holds Five Rounds
- Any ATI Top Folding or Full Length Wood or Synthetic Stocks*



Expandable Ammo Carrier

- SH06300
- Quick & Easy Access to Extra 12/20 Ga Rounds
 - Holds Five Rounds
- DuPont® Extreme Temperature Glass Reinforced Polymer



Shotforce Shotshell Holder

- SBS4300
- Holds Five 12 GA Shotshells
 - Can be Installed on Left or Right Side
 - Fits ATI Six Position Adjustable Stocks

SHOTGUN ACCESSORIES



- Single Point Sling** A.5.10.1008
- 1" Black Nylon Sling
 - High Strength Bungee Cord
 - Cushioned Non-Slip Shoulder Pad with ATI Logo
 - Attaches with Nylon-Wrapped Industrial Carabiner



- ATI Nylon Sling** A.5.10.2260
- Attaches to any Swivel Stud
 - Black Nylon
 - Laser Etched Sling Swivel
 - Leather Embossed ATI Logo



- Stock Drop Down Spacer** MRW4500
- Lower Stock Angle (1/2")
 - Improves Shooter's Bead Alignment



- ATI Sling Swivel** A.5.10.2506
- Easy Installation
 - High Quality E-Coated Steel
 - Accepts up to 1 1/4" Wide Slings
 - Virtually Indestructible



- Fluted Mag Extension Stand-off Cap** A.5.10.0500
- Fits ATI Aluminum Fluted Mag Extensions
 - Constructed of Military Type III Anodized, 6061 T6 Aluminum



- Fluted Mag Extension Swivel Stud Cap** A.5.10.0502
- Fits ATI Aluminum Fluted Mag Extensions
 - Constructed of Military Type III Anodized, 6061 T6 Aluminum



- CZ, Escort & Stoeger 12 GA Mag Follower** A.5.10.1027 (CZ), A.5.10.1026 (Escort), A.5.10.1039 (Stoeger)
- DuPont® Extreme Temperature Glass Reinforced Polymer



- Winchester SXP 12 GA Mag Follower** A.5.10.1029
- DuPont® Extreme Temperature Glass Reinforced Polymer



- Fluted Mag Extension Standard Cap** A.5.10.0501
- Fits ATI Aluminum Fluted Mag Extensions Constructed of Military Type III Anodized, 6061 T6 Aluminum Virtually Indestructible



- Mag Clamp/Accessory Clamp** SMC1100
- Strengthen the Connection of the Mag Extension to the Barrel
 - Includes Sling Swivel Stud



- 8" Talon Shotgun Forend Straight Picatinny Rail** A.5.10.1285
- Military Type III Anodized, 6061 T6 Aluminum



- Sling Loop Spacer** A.5.10.1011
- Constructed of High Strength Steel With Matte Black Powder Coating
 - Accepts all Types of Single Point Sling Attachments
- Fits ATI Talon Stocks*

SHOTGUN ACCESSORIES

Heatshield Patent # 8,656,621 B1



Mossberg 500 & 590 Standard Halo Heatshield

A.5.10.2475 & A.5.10.2495

- Constructed of High Strength Steel With Matte Black Powder Coating
- Military Type III Anodized, 6061 T6 Aluminum Picatinny Rail
- High Temp Resistant Silicon Pads Protect the Shotgun Barrel Finish

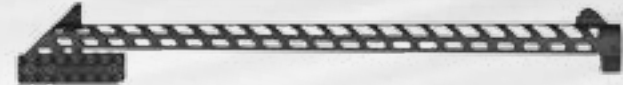

Mossberg 500 & 590 Deluxe Halo Heatshield

A.5.10.2476 & A.5.10.2496

- Constructed of High Strength Steel With Matte Black Powder Coating
- Military Type III Anodized, 6061 T6 Aluminum Picatinny Rail
- High Temp Resistant Silicon Pads Protect the Shotgun Barrel Finish
- Aluminum CNC Machined Ghost Ring Sights

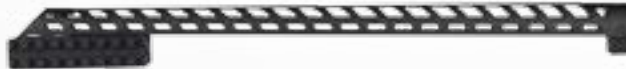

Remington 870 Standard Halo Heatshield

A.5.10.2480

- Constructed of High Strength Steel With Matte Black Powder Coating
- Military Type III Anodized, 6061 T6 Aluminum Picatinny Rail
- High Temp Resistant Silicon Pads Protect the Shotgun Barrel Finish

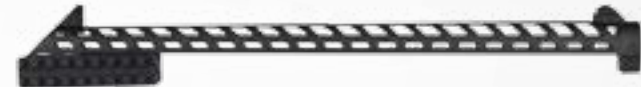

Remington 870 Deluxe Halo Heatshield

A.5.10.2481

- Constructed of High Strength Steel With Matte Black Powder Coating
- Military Type III Anodized, 6061 T6 Aluminum Picatinny Rail
- High Temp Resistant Silicon Pads Protect the Shotgun Barrel Finish
- Aluminum CNC Machined Ghost Ring Sights



Standard Heatshield

SHS1300

- Steel Formed Shotgun Heatshield
- Elongated Cooling Slots for Maximum Dissipation of Heat
- Easy Installation - Simply Slide Over Barrel and Secure With Supplied Hardware
- 13-1/2" Long



Deluxe Heatshield with Ghost Ring Sights

SBS4600

- Steel Formed Shotgun Heatshield
- Elongated Cooling Slots for Maximum Dissipation of Heat
- Easy Installation - Simply Slide Over Barrel and Secure With Supplied Hardware
- AR-15 Style Fixed Nylon Ghost Ring Sights
- 13-1/2" Long

ATI Quality

Because it's that Important to Us!



ATI Products are well known worldwide to collectors, hunting enthusiasts and members of the military and law enforcement. We have a long and proud tradition of total commitment to top quality and nothing less. All ATI Gunstocks are manufactured in the USA at our facilities in southeastern Wisconsin. Our products are easy to install, constructed with either Military Type III, 6061 T6 Aluminum or DuPont® Extreme Temperature Glass Reinforced Polymer and have a limited lifetime warranty.



To view ATI's Manufacturing processes, please visit

ATIGunstocks.com or visit [YouTube.com/user/ATIGunstocksUSA](https://www.YouTube.com/user/ATIGunstocksUSA)

Professional & Courteous Customer Service

Whether you're a new dealer or a lifelong customer of ATI products, you can always expect to receive the same high level of care and attention.

Military and Law Enforcement Discount

ATI wants to honor the brave men and women who are proudly serving our country as Military or Law Enforcement Officers.

Please contact one of our Customer Service Representatives at 800.925.2522 for more details on ATI's Military and Law Enforcement Discounts.

Lifetime Warranty

ATI's Limited Lifetime Warranty covers the product through the lifetime of the original purchaser.

The Limited Lifetime Warranty covers all manufacturers' defects. These warranties will cover any failure

or defect in the product, which is the direct responsibility of the manufacturer.

For a complete copy of ATI's Lifetime Warranty, please visit:

ATIGunstocks.com

**ATI's Unwavering
Guarantee**
Because You Matter that Much to Us!!

NEVER COMPROMISE

ATIGunstocks.com



ATI's Quality Products Sold Worldwide!



 **MADE IN THE USA**



W60 N171 Cardinal Avenue
Cedarburg, WI 53012
800.925.2522
Fax 414.464.3112



Shop online at ATIGunstocks.com